



Herramientas manuales



Remachadoras y sacabocados

Martillos, macetas, mazas y piquetas

Llaves, tenazas y corta pernos

Tornillos de banco

Destornilladores

Tijeras

Alicates de corte y manipulación

Llaves allen

Puntas y adaptadores



Herramientas manuales

Remachadoras y sacabocados

Remachadora manual

Ref.	Medidas mm	Peso	8427429	
PRF-10	265 x 75 x 34,5	600 g	640013	
CAPACIDAD DE REMACHADO				
Remache Ø mm	Aluminio	Acero	Inox	Cobre
2,4	x		x	
3,0-3,2	x	x	x	x
4,0	x	x	x	x
4,8-5,0	x			



Remachadora de dos brazos

Ref.	Medidas mm	Peso	8427429	
PRF-20	390 x 42 x Ø 26	1360 g	640020	
CAPACIDAD DE REMACHADO				
Remache Ø mm	Aluminio	Acero	Inox	Cobre
3,0-3,2	x	x	x	x
4,0	x	x	x	x
4,8	x	x	x	x
5,0	x	x	x	
6,0	x			



Sacabocados revólver

Para agujeros de 2,75 - 3 - 3,5 - 4 - 4,5 y 5 mm Ø.

Ref.	8427429
SF-40	590158









Martillos, macetas, mazas y piquetas

Martillos cabeza nylon

Mango tubular.

Ref. martillo	Medidas mm		 8427429
MNF-1	Ø 28	6	540061
MNF-2	Ø 35	6	540078
MNF-3	Ø 45	6	540085

Mango madera mangado con sistema antigiro.

Ref. martillo	Medidas mm		 8427429	Ref. mango	 8427429
MNF-10	Ø 28	6	320076	MMNF-10	320274
MNF-20	Ø 35	6	320083	MMNF-20	320281
MNF-30	Ø 45	6	320090	MMNF-30	320298

Repuestos cabezas nylon.

Ref. martillo	Medidas mm		 8427429
CNF-1	Ø 28	12	540092
CNF-2	Ø 35	12	540108
CNF-3	Ø 45	12	540115



Martillo bola mango madera

Ref. martillo	Peso		 8427429	Ref. mango	 8427429
MBF-0(A)	225	6	320021	MMBF-0	320311
MBF-1(B)	340	6	540016	MMBF-1	320328
MBF-2(C)	450	6	540030	MMBF-2	320335
MBF-4(E)	680	6	540047	MMBF-4	320359
MBF-5(F)	900	6	540054	MMBF-5	320366
MBF-6(G)	1.135	6	540283	MMBF-6	320373
MBF-7(H)	1.360	6	540290	MMBF-7	320380



Herramientas manuales

Martillo bola, mango fibra de vidrio

Mango fibra de vidrio mangado con cuña.

Ref. martillo	Peso g		 8427429	Ref. mango	 8427429
MBF-20(C)	450	6	320038	MMBF-20	320397
MBF-40(E)	680	6	320052	MMBF-40	320410
MBF-50(F)	900	6	320069	MMBF-50	320427



Martillo uña carpintero mango madera

Ref. martillo	Peso g		 8427429	Ref. mango	 8427429
MUF-1(A)	400	6	540122	MMUF-1	320434
MUF-2(B)	600	6	540139	MMUF-2	320441
MUF-3(C)	800	6	540146	MMUF-3	320458



Martillo para ebanista mango madera

Ref. martillo	Peso g		 8427429	Ref. mango	 8427429
MEMF-1(A)	140	6	540153	MMEMF-1	320465
MEMF-2(B)	180	6	540160	MMEMF-2	320472
MEMF-3(C)	210	6	540177	MMEMF-3	320489
MEMF-4(D)	340	6	540184	MMEMF-4	320496





Maceta modelo español mango madera



Ref. maceta	Peso kg		 8427429	Ref. mango	 8427429
MZF-0 (0)	750	6	320106	MMZF-0	320502
MZF-1 (A)	1.000	6	320113	MMZF-1	320519
MZF-2 (B)	1.250	6	320137	MMZF-2	320526



Maceta modelo español mango fibra de vidrio



Ref. maceta	Peso kg		 8427429	Ref. mango	 8427429
MZF-10 (A)	1.000	6	320120	MMZF-10	320533
MZF-20 (B)	1.250	6	320144	MMZF-20	320540

Maza de goma, mango madera



Ref. maza	Medidas mm		 8427429
MGF-1 (9)	Ø 58 x 90	6	540191
MGF-2 (12)	Ø 65 x 120	6	540207
MGF-3 (15)	Ø 85 x 120	6	540214

Piqueta soldador mango tubular



Ref. piqueta	Peso g		 8427429
PSF-1	300	6	540306

LLaves, tenazas y corta pernos

LLaves tipo stillson

Ref.	Pulgadas		8427429
LLSF-1	10"	6	540221
LLSF-2	12"	6	540238
LLSF-3	14"	6	540245
LLSF-4	18"	6	540252
LLSF-5	24"	2	540269
LLSF-6	36"	1	540276



LLaves tipo ridgid aluminio

Ref.	Pulgadas		8427429
LLSF-10	12"	6	320755
LLSF-11	14"	6	320762
LLSF-12	18"	6	320779
LLSF-13	24"	1	320786
LLSF-14	36"	1	320793



LLaves ajustables

Especificaciones:

- Material: Cromo-vanadio forjado en acero líquido.
- Acabado: Cromo plateado.
- De moleta central tipo profesional.
- Dispone de escala métrica.

Ref.	Pulgadas		8427429
LLAF-1	150-6"	6	700458
LLAF-2	200-8"	6	700465
LLAF-3	250-10"	6	700472
LLAF-4	300-12"	6	700489
LLAF-5	380-15"	6	700496



Grip de boca curva en cromo-vanadio.

Ref.	Pulgadas		8427429
GF-100-7	7"	6	140063
GF-100-10	10"	6	140070
GF-100-12	12"	4	140087



Grip de boca recta en cromo-vanadio.

Ref.	Pulgadas		8427429
GF-110-10	10"	6	140100





Llaves fijas de 2 bocas abiertas

Especificaciones:

- Material: Cromo-vanadio.
- Acabado: Cromo plateado.
- Ángulo de apertura 15°, que permite una rápida utilización y mejora el acceso a espacios reducidos.
- DIN 3110.
- ISO 10102.



Ref.		L mm	E mm	Peso g		 8427429
LF0607	6 x 7	122	3,4	19	10	320885
LF0809	8 x 9	140	3,9	30	10	320892
LF0810	8 x 10	140	3,9	31	2	320908
LF1011	10 x 11	156	4,7	45	10	320915
LF1012	10 x 12	156	4,7	45	2	320922
LF1013	10 x 13	172	5,2	57	10	320939
LF1213	12 x 13	173	5,2	68	10	320946
LF1317	13 x 17	204	6,1	113	2	320953
LF1415	14 x 15	189	5,6	96	10	320960
LF1417	14 x 17	204	6,1	115	2	320977
LF1617	16 x 17	205	6,1	125	10	320984
LF1719	17 x 19	222	6,5	155	10	320991
LF1819	18 x 19	223	6,5	157	5	321004
LF1922	19 x 22	236	6,9	196	5	321011
LF2022	20 x 22	236	7,3	210	5	321028
LF2123	21 x 23	249	7,5	260	5	321035
LF2224	22 x 24	255	7,6	265	5	321042
LF2426	24 x 26	265	7,7	335	5	321059
LF2427	24 x 27	266	7,8	340	3	321066
LF2528	25 x 28	279	8,2	370	3	321073
LF2732	27 x 32	285	8,8	450	1	321080
LF3032	30 x 32	301	9,0	510	1	321097
LF3236	32 x 36	301	9,0	613	1	321103
LF3641	36 x 41	358	13,0	905	1	321110

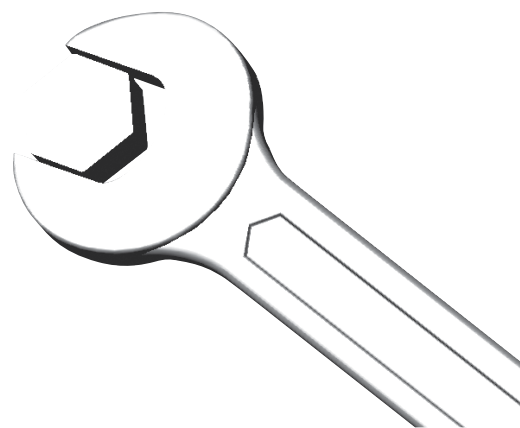
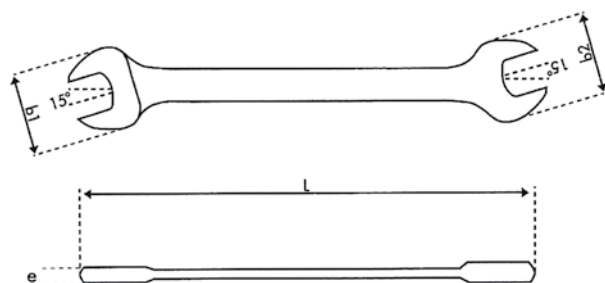

Juego de llaves fijas

Ref.	Nº Piezas	Contenido	Peso g	 8427429
JLF-8	8	6 x 7, 8 x 9, 10 x 11, 12 x 13 14 x 15, 16 x 17, 18 x 19, 20 x 22	991	321783



Herramientas manuales

Tenazas

Especificaciones:

- Material: Cromo-vanadio.
- Acabado: Negro.
- Mangos: PVC.



DE ABERTURA MÚLTIPLE CON CANAL

Ref.	Medidas		 8427429
TAM-2	250 mm	6	700441

Especificaciones:

- Material: Cromo-vanadio.
- Acabado: Pavonado con cabeza pulida.
- Mangos: Recubiertos en PVC.
- Din 9242.



RUSA

Ref.	Medidas		 8427429
TER-1	225 mm	6	341606
TER-2	250 mm	6	341613
TER-3	280 mm	6	341620

Corta pernos



Ref. cortapernos	Medidas mm Largo / Corte		 8427429	Ref. cuchilla	 8427429
CPRF-1	460 / 6	1	320809	CHR-1	320847
CPRF-2	610 / 8	1	320816	CHR-2	320854
CPRF-3	760 / 10	1	320823	CHR-3	320861
CPRF-4	960 / 13	1	320830	CHR-4	320878



Tornillos de banco

Tornillos de banco en hierro fundido

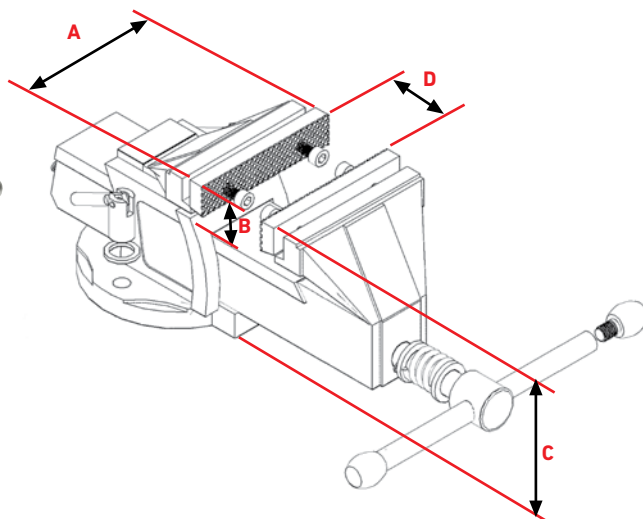
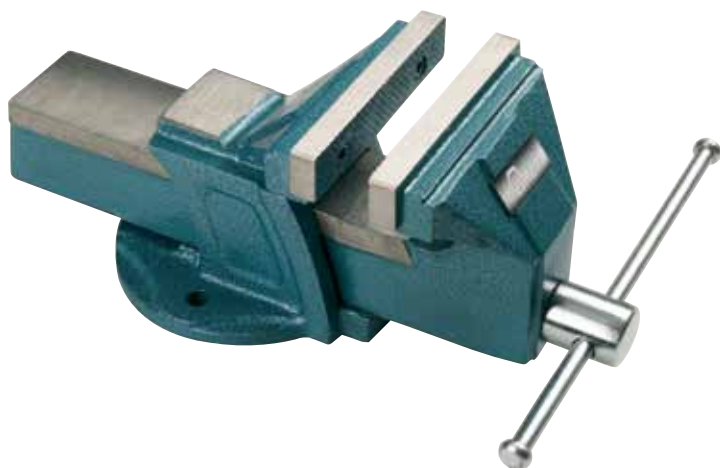

FIJOS

Ref.	-A- Ancho	-B- Alto	-C- Altura Máxima	-D- Apertura Máxima	Peso kg	8427429
TBF-10	63 mm	49 mm	100 mm	87 mm	3,8	570068
TBF-11	80 mm	46 mm	105 mm	90 mm	4,4	570075
TBF-12	100 mm	54 mm	114 mm	120 mm	5,5	570082
TBF-13	125 mm	70 mm	140 mm	150 mm	9,2	570099
TBF-14	150 mm	84 mm	165 mm	183 mm	12	570105
TBF-15	200 mm	100 mm	220 mm	248 mm	19	330013

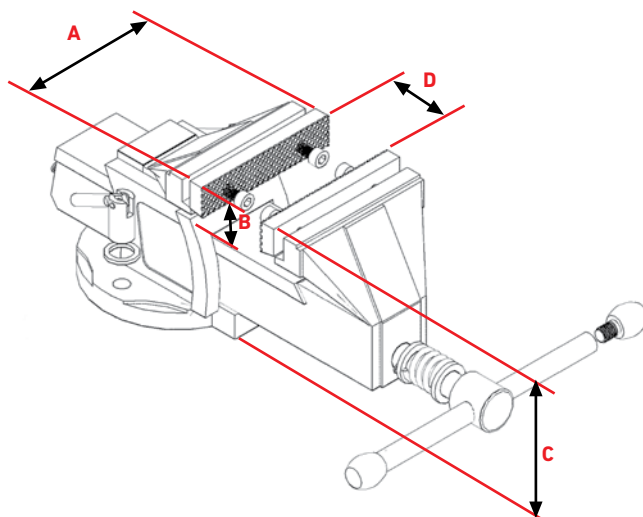
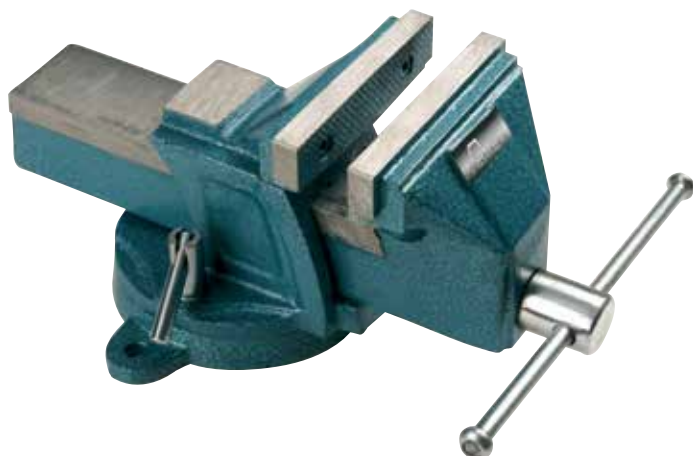

GIRATORIOS

Ref.	-A- Ancho	-B- Alto	-C- Altura Máxima	-D- Apertura Máxima	Peso kg	8427429
TBF-1	63 mm	49 mm	125 mm	87 mm	4,0	570013
TBF-2	80 mm	46 mm	125 mm	90 mm	4,6	570020
TBF-3	100 mm	54 mm	134 mm	120 mm	5,8	570037
TBF-4	125 mm	70 mm	164 mm	150 mm	9,5	570044
TBF-5	150 mm	84 mm	187 mm	183 mm	12,4	570051
TBF-6	200 mm	100 mm	194 mm	248 mm	19,4	330020

Destornilladores



- Cromo de alta calidad, el material más adecuado para la fabricación de varillas de destornilladores, dureza 59-60 HRc, chapeada en cromo mate y magnetizada aportando una mayor adherencia tornillo-punta y una total garantía anti-corrosión.
- Mango bimataterial. Reduce la fatiga transmitiendo más poder. El diseño basado en formas redondeadas y sin aristas confiere al destornillador una máxima ergonomía perfectamente adaptada a los esfuerzos de los músculos de la mano. Gracias a este diseño, el trabajo se hace con la máxima comodidad y el mínimo esfuerzo.

Boca plana

- Material: Cr - Mo - V.
- DIN 5265 - ISO 2380.



Ref.	mm	mm		 8427429
DMPL-34	6,5	100	12	341644
DMPL-35	6,5	125	12	321158
DMPL-40	6,5	150	12	340623
DMPL-41	6,5	200	12	341651
DMPL-50	8,0	150	12	340630
DMPL-55	8,0	175	12	321165
DMPL-60	10,0	200	12	321172
DMPL-70	12,0	250	12	321189

Boca recta



Ref.	mm	mm		 8427429
DMBR-5	2,5	75	12	341668
DMBR-6	3,0	75	12	341675
DMBR-10	3,0	100	12	321196
DMBR-20	3,5	100	12	321202
DMBR-25	4,0	75	12	341682
DMBR-30	4,0	100	12	321219
DMBR-35	4,0	125	12	341699
DMBR-36	4,0	150	12	341705







EXTRA LARGO

Ref.	 mm	 mm		 8427429
DMBR-60	4,0	300	12	341743
DMBR-65	5,5	300	12	341750
DMBR-70	6,5	300	12	341767

Boca plana, varilla de perfil hexagonal

- Varilla con hexágono conductor que permite la aplicación de una llave, para trabajos exigentes que precisen de alto par de apriete.
- Material: Cr - Mo - V.
- DIN 5265 - ISO 2380.







Ref.	 mm	 mm		 8427429
DMH-10	5,5	100	12	321240
DMH-20	6,5	125	12	321257
DMH-30	8,0	150	12	321264

Extracorto boca plana

- Material: Cr - Mo - V.
- DIN 5265 - ISO 2380.



Ref.	 mm	 mm		 8427429
DCPL-1	4,0	25	12	340432
DCPL-2	5,5	25	12	340449
DCPL-3	6,5	25	12	340456

Boca phillips

- Material: Cr - Mo - V.
- DIN 5262 - ISO 8764-PH.



Ref.		mm		8427429
DMPH-5	PH0	60	12	321288
DMPH-10	PH0	80	12	340517
DMPH-20	PH1	80	12	340524
DMPH-30	PH1	100	12	340531
DMPH-31	PH1	125	12	341774
DMPH-35	PH1	200	12	321295
DMPH-40	PH2	100	12	340548
DMPH-50	PH2	125	12	340562
DMPH-51	PH2	150	12	341781
DMPH-55	PH2	200	12	321318
DMPH-60	PH3	150	12	340586
DMPH-65	PH4	200	12	321332



EXTRA LARGO

Ref.		mm		8427429
DMPH-36	PH1	300	12	321301
DMPH-56	PH2	300	12	321325

Boca phillips, varilla de perfil hexagonal

- Varilla con hexágono conductor que permite la aplicación de una llave, para trabajos exigentes que precisen de alto par de apriete.
- Material: Cr - Mo - V.
- DIN 5262 - ISO 8764-PH.







Ref.		mm			8427429
DPH-10	PH1	80	8	12	321349
DPH-20	PH2	100	10	12	321356
DPH-30	PH3	150	13	12	321363



Extracorto boca phillips

- Material: Cr - Mo - V.
- DIN 5262 - ISO 8764-PH.





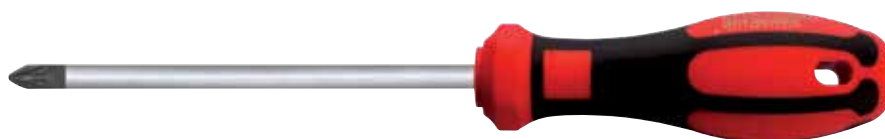

Ref.				 8427429
DCPH-1	PH1	25	12	340418
DCPH-2	PH2	25	12	340425

Boca pozidriv

- Material: Cr - Mo - V.
- DIN 5262 - ISO 8764-PZ.





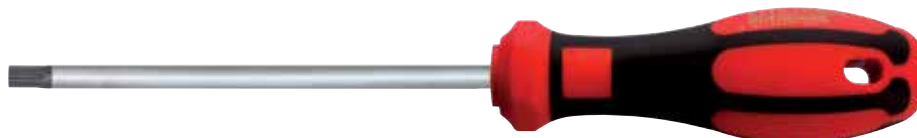

Ref.				 8427429
DMPZ-0	PZ0	60	12	341521
DMPZ-1	PZ1	80	12	341538
DMPZ-2	PZ2	100	12	341545
DMPZ-3	PZ3	150	12	341552

Boca torx

- Material: Cr - Mo - V.







Ref.				 8427429
DMT-10	T5	60	12	321790
DMT-20	T6	60	12	321806
DMT-30	T7	60	12	321813
DMT-40	T8	60	12	321820
DMT-50	T9	60	12	321837
DMT-60	T10	80	12	321844
DMT-70	T15	80	12	321851
DMT-80	T20	100	12	321868
DMT-90	T25	100	12	321875
DMT-100	T27	115	12	321882
DMT-110	T30	115	12	321899
DMT-120	T40	130	12	321905
DMT-130	T45	130	12	322209

Herramientas manuales







EXTRA LARGO

Ref.		 mm		 8427429
DMT-160	T20	300	12	341798
DMT-170	T25	300	12	341804
DMT-180	T30	300	12	341811

Boca torx inviolable

· Material: Cr - Mo - V.







Ref.		 mm		 8427429
DMTI-10	T10	80	12	321912
DMTI-20	T15	80	12	321929
DMTI-30	T20	100	12	321936
DMTI-40	T25	100	12	321943
DMTI-50	T27	115	12	321950
DMTI-60	T30	115	12	321967
DMTI-70	T40	130	12	321974

Hexagonal esférico

· Material: Cr - Mo - V.







Ref.		 mm		 8427429
DHE-10	3,0	100	12	321981
DHE-20	4,0	100	12	321998
DHE-30	5,0	100	12	322018
DHE-40	6,0	125	12	322025
DHE-50	8,0	150	12	322032

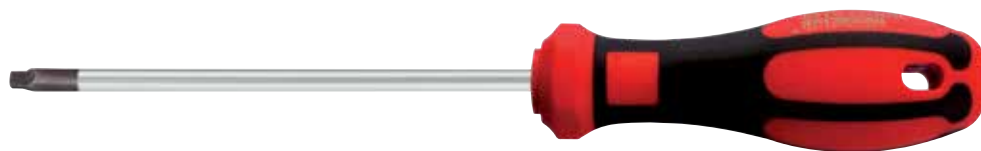

Boca robertson

· Material: Cr - Mo - V.







Ref.		 mm		 8427429
DBR-10	N° 1	100	12	322049
DBR-20	N° 2	125	12	322056
DBR-30	N° 3	150	12	322063

Llave de vaso

· Material: Cr - Mo - V.

· DIN 3125 - ISO 2236.



Ref.		 mm		 8427429
DLV-10	4,0	125	12	322070
DLV-20	5,0	125	12	322087
DLV-30	5,5	125	12	322094
DLV-40	6,0	125	12	322100
DLV-50	7,0	125	12	322117
DLV-60	8,0	125	12	322124
DLV-70	9,0	125	12	322131
DLV-80	10,0	125	12	322148
DLV-90	11,0	125	12	322155
DLV-100	12,0	125	12	322162
DLV-110	13,0	125	12	322179
DLV-120	14,0	125	12	322186

Reversible

· DIN 5264 - B, ISO 2380; DIN 5260, ISO 8764 - PH.







Ref.		 mm		 8427429
DR-1	PH2	6,0	12	322193

Herramientas manuales

Mango multisistema para fillos reversibles

- Material: Cr - Mo - V.
- DIN 5265 - ISO 2380.



Ref.	 mm	 mm		 8427429
MMR	6	109 x 37	6	340937

FILOS REVERSIBLES PARA MANGO MULTISISTEMA (Portapuntas hexagonal magnético)







Ref.	 mm		 mm		 8427429
RMM-1	1/4"	175	6	6	340951







Juego de destornilladores en caja de cartón



- Caja de destornilladores planos y phillips de 6 piezas.
- Cada juego contiene 1 pieza de cada referencia.









Ref.	 mm	 mm
DMBR-6	3,0	75
DMBR-30	4,0	100
DMBR-40	5,5	125
DMPL-40	6,5	150
Ref.	 mm	 mm
DMPH-20	PH1	80
DMPH-40	PH2	100



Ref.		
JDF-1	1	8427429 340685



Expositor con destornilladores

- Contiene 67 piezas.
- DMPL =  DMPH =  DMPZ = 

Ref.	 mm	 mm	
DMBR-6	3,0	75	7
DMBR-30	4,0	100	6
DMBR-40	5,5	125	12
DMPL-40	6,5	150	6
DMPL-55	8,0	175	5
Ref.	 mm	 mm	
DMPH-40	PH2	100	6
Ref.	 mm	 mm	
DMPZ-0	PZ0	60	7
DMPZ-1	PZ1	80	6
DMPZ-2	PZ2	100	12

Ref.		
EJD67	1	8427429 321370



Herramientas manuales

Electricista boca plana, varilla aislada

- Material: Cr - Mo - V.
- DIN 7437, DIN 5264 - ISO 2380.



Ref.	Ø mm	mm		 8427429
DEBP-5	2,5	75	12	700182
DEBP-10	3,0	100	12	340463
DEBP-15	3,5	100	12	321776
DEBP-20	4,0	100	12	340470
DEBP-30	5,5	125	12	340487
DEBP-40	6,5	150	12	340494
DEBP-50	8,0	175	12	340500

Electricista boca phillips, varilla aislada

- Material: Cr - Mo - V.
- DIN 7438 - ISO 8764-PH.



Ref.		mm		 8427429
DTEP-10	PH0	60	12	340647
DTEP-20	PH1	80	12	340654
DTEP-30	PH2	100	12	340661
DTEP-35	PH2	150	12	341828
DTEP-40	PH3	150	12	340678

Boca pozidriv





- Material: Cr - Mo - V.
- DIN 7438 - ISO 8764-PZ.



Ref.		mm		 8427429
DEPZ-0	PZ0	60	12	341484
DEPZ-1	PZ1	80	12	341491
DEPZ-2	PZ2	100	12	341507
DEPZ-3	PZ3	150	12	341514



Juego de destornilladores en caja de cartón

Ref.	 mm	 mm
DEBP-10	3,0	100
DEBP-20	4,0	100
DEBP-30	5,5	125
DEBP-40	6,5	150
Ref.	 mm	 mm
DTEP-20	PH1	80
DTEP-30	PH2	100
DBPF	Buscapolos	15

- Juego de destornilladores de electricista planos y phillips de 7 piezas.
- Cada juego contiene 1 pieza de cada referencia.

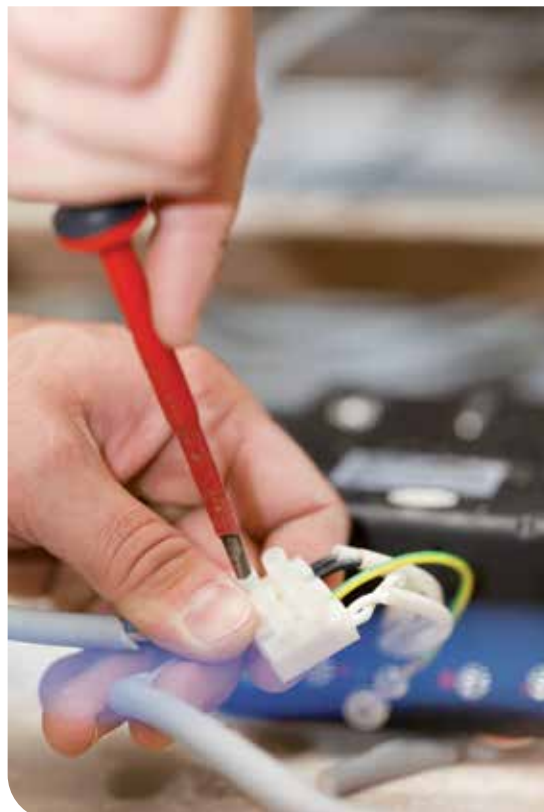





Ref.		 8427429
JDF-2	1	340692



Buscapolos

- VDE 0680/06 , DIN 57680/06.
- Para testear intervalos 150-250 V.



Ref.	 mm	 mm	 mm		 8427429
DBPF	3,0	15	139	12	340401

Tijeras

Electricista

Ref.	Medidas		 8427429
TGEF	5"	12	150406

- Mangos termoplásticos.
- Se sirve en blister.



Ref.	Medidas		 8427429
TGEF-1	5 3/4"	6	321127

- Fabricada en Acero Inoxidable. Mangos de elastómero blando que proporciona un mejor agarre y confort al usuario.
- Se sirve en blister.





Alicates de corte y manipulación

Especificaciones:

- Material: Cromo-vanadio.
- Acabado: Cromo plateado.
- Mangos: Estilo europeo con dos tonos.

Universal cabeza cromada

· DIN / ISO 5746

Ref.	Medidas		 8427429
AEC-1	160 mm	6	700090
AEC-2	180 mm	6	700106
AEC-3	200 mm	6	700113





Corte diagonal

· DIN / ISO 5749

Ref.	Medidas		 8427429
ACC	140 mm	6	341835
ACC-1	160 mm	6	700014
ACC-2	180 mm	6	341842



REFORZADO

Ref.	Medidas		 8427429
ACC-3	180 mm	6	341859
ACC-4	200 mm	6	341866

Semicircular cabeza cromada

· DIN / ISO 5745

Ref.	Medidas		 8427429
ASC-1	160 mm	6	700137
ASC-2	200 mm	6	341873



Boca plana cabeza cromada

· DIN / ISO 5745

Ref.	Medidas		 8427429
ARC-1	160 mm	6	700120



Herramientas manuales

Curvado boca semiredonda

· DIN / ISO 5745

Ref.	Medidas		 8427429
ACIC-1	160 mm	6	700076
ACIC-2	200 mm	6	700083



Universal de manipulación. Electricista

· DIN / ISO 5746



Ref.	Medidas		 8427429
AME-1	160 mm	6	341576
AME-2	180 mm	6	341583
AME-3	200 mm	6	341590



Corte diagonal. Electricista

· DIN / ISO 5749



Ref.	Medidas		 8427429
ACDE-1	160 mm	6	341569
ACDE-2	180 mm	6	341880



Pelacables. Electricista

· Tuerca moteada para ajuste con una mano. Capacidad de banda: máx: 10 mm², mecanismo con muelle.



Ref.	mm	pulgadas	form.	Ø mm ²		 8427429
PLC	160	6		10	6	340944





Llaves allen

De brazo corto

- Fabricadas en acero cromo-vanadio-molibdeno, endurecido en níquel plateado con brillo.
- DIN 911, ISO 2936
- DUREZA: 1,5-8,0 mm - 52 HCR. 10,0 - 12,0 - 48 HRC.

Ref.	mm	mm	mm	g		8427429
L/1,5	1,5	14	46	1	12	340722
L/2,0	2,0	16	51	1	12	340760
L/2,5	2,5	18	58	2	12	340777
L/3,0	3,0	20	65	4	12	340784
L/4,0	4,0	25	74	10	12	340791
L/5,0	5,0	28	85	18	12	340807
L/6,0	6,0	32	96	32	12	340814
L/8,0	8,0	36	106	60	12	340821
L/10,0	10,0	40	125	105	12	340739
L/12,0	12,0	45	137	171	12	340746



Juego llaves de brazo corto

- Envasadas en un clip de plástico de alta calidad 9 piezas.
- Cada juego contiene 1 pieza de cada referencia.

Ref.	mm	mm	mm
L/1,5	1,5	14	46
L/2,0	2,0	16	51
L/2,5	2,5	18	58
L/3,0	3,0	20	65
L/4,0	4,0	25	74
L/5,0	5,0	28	85
L/6,0	6,0	32	96
L/8,0	8,0	36	106
L/10,0	10,0	40	125







Ref.	g		8427429
JLH-9	247	1	340708



Herramientas manuales

De brazo largo con cabeza de bola



- Ángulo de entrada hasta 25°.
- Fabricadas en acero cromo-vanadio-molibdeno, endurecido en níquel plateado con brillo.
- DIN 911, ISO 2936-L.
- Dureza: 1,5 - 8,0 mm - 52 HRC. 10 mm - 48 HRC.

Ref.	 mm	 mm	 mm			 8427429
LL/1,5	1,5	14	90	1,5	12	340838
LL/2,0	2,0	16	100	3	12	340869
LL/2,5	2,5	18	112	5	12	340876
LL/3,0	3,0	20	129	8	12	340883
LL/4,0	4,0	25	142	18	12	340890
LL/5,0	5,0	28	164	31	12	340906
LL/6,0	6,0	32	185	51	12	340913
LL/8,0	8,0	36	205	104	12	340920
LL/10,0	10,0	40	230	182	12	340845



Juego llaves con cabeza de bola

- Juego de llaves hexagonales con cabeza de bola, brazo largo. Envasadas en un clip de plástico de alta calidad, 9 piezas.
- Cada juego contiene 1 pieza de cada referencia.

Ref.	 mm	 mm	 mm
LL/1,5	1,5	14	90
LL/2,0	2,0	16	100
LL/2,5	2,5	18	112
LL/3,0	3,0	20	129
LL/4,0	4,0	25	142
LL/5,0	5,0	28	164
LL/6,0	6,0	32	185
LL/8,0	8,0	36	205
LL/10,0	10,0	40	230

Ref.			 8427429
JLLH-9	416	1	340715









Puntas y adaptadores

Portapuntas magnético combinado

- Para puntas hexagonales de 1/4", mango de acetato celulosa rojo con alojamiento para puntas. Dispone de un potente dispositivo magnético. Filo en cromo plateado mate.
- Incluye 6 puntas plana, phillips y pozidriv.
- Cada juego contiene 1 pieza de cada referencia.

Ref.	Puntas	
CB/611	Plana	25
CB/612	Plana	25
CB/613	Plana	25
CB/251	Phillips	25
CB/252	Phillips	25
CB/351	Pozidriv	25

Ref.				 8427429
3100/BT5C	1/4"	100	1	340012



Destor puntas



- Material: Cromo-vanadio-molibdeno
- Destor: 1/4" hex., DIN 3126 - C 6.3 ISO 1173.
- Dureza: 58-62 HRC.



BOCA PLANA - LARGO 25 mm				
Ref.				 8427429
CB/611	4,0	0,5	10	340241
CB/610	4,5	0,6	10	340234
CB/612	5,5	0,8	10	340258
CB/613	6,5	1,2	10	340265

- Boca: DIN 5264-C, ISO 2380.



BOCA PHILLIPS - LARGO 25 mm			
Ref.			 8427429
CB/250	PH0	10	321394
CB/251	PH1	10	340173
CB/252	PH2	10	340180
CB/253	PH3	10	340197

- Boca: DIN 5260, ISO 8764-PH.

PHILLIPS SERIE DURAMAX 25 mm			
Ref.			 8427429
CB/251 TIN	PH1	10	341101
CB/252 TIN	PH2	10	341118
CB/253 TIN	PH3	10	341125

- Boca: DIN 5260, ISO 8764-PH.

Herramientas manuales

Destoropuntas



BOCA POZIDRIV - LARGO 25 mm			
Ref.			
CB/350	PZ0	10	321400
CB/351	PZ1	10	340203
CB/352	PZ2	10	340210
CB/353	PZ3	10	340227

· Boca: DIN 5260, ISO 8764-PZ.



POZIDRIV SERIE DURAMAX 25 mm			
Ref.			
CB/351 TIN	PZ1	10	341132
CB/352 TIN	PZ2	10	341149
CB/353 TIN	PZ3	10	341156

· Boca: DIN 5260, ISO 8764-PZ.



BOCA TORX - LARGO 25 mm			
Ref.			
CB/801	T5	10	340272
CB/802	T6	10	340289
CB/803	T7	10	340296
CB/804	T8	10	340302
CB/805	T9	10	340319
CB/806	T10	10	340326
CB/807	T15	10	340333
CB/808	T20	10	340340
CB/809	T25	10	340357
CB/810	T27	10	340364
CB/811	T30	10	340371
CB/812	T40	10	340388

· Boca: DIN 3126 - C 6.3, ISO 1173.



BOCA TORX INVOLABLE 6 PUNTAS LARGO 25 mm			
Ref.			
CB/806T	T10	10	321547
CB/807T	T15	10	321554
CB/808T	T20	10	321561
CB/809T	T25	10	321578
CB/810T	T27	10	321585
CB/811T	T30	10	321592
CB/812T	T40	10	321608

· Boca: DIN 3126 - C 6.3, ISO 1173.



BOCA TORX INVOLABLE 5 PUNTAS LARGO 25 mm (PARA AUTOMOCIÓN)			
Ref.			
CB/806TP	TP10	10	321615
CB/807TP	TP15	10	321622
CB/808TP	TP20	10	321639
CB/809TP	TP25	10	321646
CB/811TP	TP30	10	321653
CB/812TP	TP40	10	321660

· Boca: DIN 3126 - C 6.3, ISO 1173.



BOCA XZN - LARGO 25 mm			
Ref.			
CB/854	M4	10	321677
CB/855	M5	10	321684
CB/856	M6	10	321691
CB/858	M8	10	321707

· Boca: DIN 3126 - C 6.3, ISO 1173.



Destorpuntas



BOCA ROBERTSON 1/4" - LARGO 25 mm

Ref.			8427429
CB/841	N° 1	10	321714
CB/842	N° 2	10	321721
CB/843	N° 3	10	321738

· Boca: DIN 3126 - C 6.3, ISO 1173.

BOCA HEXAGONAL - LARGO 25 mm

Ref.	mm		8427429
CB/1815	1,5	10	340104
CB/1820	2,0	10	340111
CB/1825	2,5	10	340128
CB/1830	3,0	10	340135
CB/1840	4,0	10	340142
CB/1850	5,0	10	340159
CB/1860	6,0	10	340166

· Boca: ISO 2936.



BOCA PLANA - LARGO 50 mm

Ref.	mm	mm		8427429
CB/619	3,0	0,5	10	341286
CB/620	4,0	0,8	10	341293
CB/621	5,5	1,0	10	341309
CB/622	6,5	1,2	10	341316

· Boca: DIN 5264-C, ISO 2380.



BOCA PHILLIPS - LARGO 50 mm

Ref.			8427429
CB/491	PH1	10	341163
CB/492	PH2	10	341187
CB/493	PH3	10	341200

· Boca: DIN 5260, ISO 8764-PH.

PHILLIPS SERIE DURAMAX 50 mm

Ref.			8427429
CB/491 TIN	PH1	10	341170
CB/492 TIN	PH2	10	341194
CB/493 TIN	PH3	10	341217

· Boca: DIN 5260, ISO 8764-PH.

Herramientas manuales



BOCA POZIDRIV - LARGO 50 mm

Ref.			
CB/591	PZ1	10	8427429 341224
CB/592	PZ2	10	8427429 341248
CB/593	PZ3	10	8427429 341262

· Boca: DIN 5260, ISO 8764-PZ.

POZIDRIV SERIE DURAMAX 50 mm

Ref.			
CB/591 TIN	PZ1	10	8427429 341231
CB/592 TIN	PZ2	10	8427429 341255
CB/593 TIN	PZ3	10	8427429 341279

· Boca: DIN 5260, ISO 8764-PZ.



BOCA TORX - LARGO 50 mm

Ref.			
CB/822	T8	10	8427429 341392
CB/823	T9	10	8427429 341408
CB/824	T10	10	8427429 341415
CB/825	T15	10	8427429 341422
CB/826	T20	10	8427429 341439
CB/827	T25	10	8427429 341446
CB/828	T27	10	8427429 341453
CB/829	T30	10	8427429 341460
CB/830	T40	10	8427429 341477

BOCA HEXAGONAL - LARGO 50 mm

Ref.	 mm		
CB/1915	1,5	10	8427429 341033
CB/1920	2,0	10	8427429 341040
CB/1925	2,5	10	8427429 341057
CB/1930	3,0	10	8427429 341064
CB/1940	4,0	10	8427429 341071
CB/1950	5,0	10	8427429 341088
CB/1960	6,0	10	8427429 341095





Puntas reversibles

- Material: Cromo-vanadio-molibdeno.
- Dureza: 58-62 HRC.
- Destor: 1/4" hex.
- Boca: DIN 5264-C, DIN 5260-PH & PZ.

PLANAS-PHILLIPS 60 mm					
Ref.	mm	mm	mm		8427429
CB/661	4,5	PH1	60	5	341330
PHILLIPS-POZIDRIV 60 mm					
Ref.	mm	mm	mm		8427429
CB/663	PH1	PZ1	60	5	341354
CB/660	PH2	PZ2	60	5	341323
PHILLIPS-PHILLIPS 60 mm					
Ref.	mm	mm	mm		8427429
CB/664	PH2	PH2	60	5	341361
PLANA-POZIDRIV 60 mm					
Ref.	mm	mm	mm		8427429
CB/665	4,5	PZ1	60	5	341378



Porta puntas stecker magnético

- Material: Cromo-vanadio-molibdeno.
- Dureza: 58-62 HRC.
- Destor: 1/4" hex. DIN 3126 E 6.3, ISO 1173.



Ref.	mm	mm	g		8427429
BT/0542	5,5	42	17	3	340043
BT/0642	6,0	42	18	3	340050
BT/0742	7,0	42	19	3	340999
BT/0842	8,0	42	20	3	340074
BT/0865	8,0	65	33	3	321424
BT/1045	10,0	45	23	3	340081
BT/1065	10,0	65	37	3	321431
BT/1165	11,0	65	45	3	321448
BT/1265	12,0	65	45	3	321455
BT/1365	13,0	65	60	3	321462
BT/1465	14,0	65	62	3	321479
BT/1765	17,0	65	70	3	321486



Adaptadores

- Material: Cromo-vanadio-molibdeno.
- Dureza: 58-62 HRC.
- Adap: 1/4" hex., DIN 3126 - E 6.3, ISO 1173.



ADAPTADOR PARA VASOS DE 1/4" Y 3/8" 25 mm

Ref.			 mm		 8427429
BT/7010	1/4"	1/4"	25	10	341002

- DIN 3126 - C6.3, ISO 1173.



ADAPTADOR MAGNÉTICO CON HEXÁGONO CONDUCTOR

Ref.		 mm		 8427429
BT/02	1/4"	60	3	340029
BT/03	1/4"	75	3	340036
BT/05	1/4"	150	3	321493



ADAPTADOR PARA VASOS DE 1/4", 3/8" Y 1/2" 50-100 mm

Ref.			 mm		 8427429
BT/7015	1/4"	1/4"	50	3	341019
BT/7018	1/4"	1/4"	100	3	321516
BT/7020	3/8"	1/4"	50	3	341026
BT/7028	3/8"	1/4"	100	3	321523
BT/7030	1/2"	1/4"	50	3	321530

- DIN 3126 - E 6.3, ISO 1173.



ADAPTADOR MAGNÉTICO PARA PUNTAS CON ACOPLAMIENTO RÁPIDO 1/4"

Ref.		 mm		 8427429
BT/01QH	1/4"	60	3	321745



Adaptadores



ADAPTADOR MAGNÉTICO PARA TORNILLO CON ACOPLAMIENTO RÁPIDO 1/4"

Ref.	mm	mm		8427429
BT/01SH	1/4"	60	3	321752



Juego de bocas universales

- Juego de bocas universales planas, phillips estrella, TORX, y hexagonales envasados en una caja de plástico de 61 piezas.

Ref.	mm	mm	
CB/611	4,0	25	1
CB/612	5,5	25	1
CB/613	6,5	25	1

Ref.		mm	
CB/250	PH0	25	1
CB/251	PH1	25	1
CB/252	PH2	25	10
CB/253	PH3	25	1

Ref.		mm	
CB/350	PZ0	25	1
CB/351	PZ1	25	1
CB/352	PZ2	25	10
CB/353	PZ3	25	1

Ref.		mm	
CB/841	N° 1	25	1
CB/842	N° 2	25	1
CB/843	N° 3	25	1

Ref.		mm	
BT/02	1/4"	60	1
BT/8001	1/4" - 1/4"	25	1
CB/800IPR	IPR20	25	1

Ref.		mm	
CB802	T6	25	1
CB803	T7	25	1
CB804	T8	25	1
CB805	T9	25	1
CB/806	T10	25	1
CB/807	T15	25	1
CB/808	T20	25	2
CB/809	T25	25	1
CB/810	T27	25	1
CB/811	T30	25	2
CB/812	T40	25	1

Ref.		mm	
CB/806T	T10	25	1
CB/807T	T15	25	1
CB/808T	T20	25	1
CB/809T	T25	25	1
CB/810T	T27	25	1
CB/811T	T30	25	1
CB/812T	T40	25	1

Ref.		mm	
CB/1820	2,0	25	1
CB/1825	2,5	25	1
CB/1830	3,0	25	1
CB/1840	4,0	25	1
CB/1850	5,0	25	1
CB/1860	6,0	25	1

Ref.		8427429
CB/ST1	1	340395

